

Installer Guide

Universal Programmable Smart Wi-Fi Thermostat

7205 Up to 3 Heat / 2 Cool Heat Pump
Up to 2 Heat / 2 Cool Conventional

Model number is located on back of thermostat.

See Wi-Fi Setup Guide for Wi-Fi Setup Instructions

1 Specifications 2 Installation and Wiring 3 Quick Reference
4 Installer Settings 5 System Testing

 **Warning** *For installation by experienced service technicians only.*

 **Caution** • *Possible electric shock or damage to equipment can occur.*
• *Disconnect power before beginning installation.*

*This thermostat requires 24 Volt AC Power or 2 properly installed “AA” Alkaline batteries for proper operation. **If connecting this thermostat to a Wi-Fi network, a 24 VAC common (C wire) may be required (see page 3).** Thermostat installation and all components of the system shall conform to Class II Circuits per NEC code.*

For use only as described in this manual. Any other use will void warranty.

1 Specifications

This thermostat is compatible with:

- Single stage heat / cool conventional and heat pump systems
- Conventional systems up to 2 stages of heating and 2 stages of cooling
- Heat pump systems up to 3 stages of heating and 2 stages of cooling

Electrical and control specifications:

- Electrical Rating: 24 Volt AC
- 1 amp maximum load per terminal
- AC Power: 18 – 30 Volts AC
- DC Power: 3.0 Volt DC (2 “AA” Alkaline Batteries Included)
- Control Range: 45° – 90° F (7° – 32° C)
- Temperature Accuracy: +/- 1° F (+/- .5° C)

Terminations

Rh, Rc, C, W1/E/W3, W2, O/B, G, Y2, Y1, K

2 Installation and Wiring



Warning *Disconnect power before beginning installation.*

Thermostat Location

Install the thermostat approximately 5 feet (1.5m) above the floor in an area that has a good amount of air circulation and maintains an average room temperature.

Avoid installation in locations where the thermostat can be affected by drafts, dead air spots, hot or cold air ducts, sunlight, appliances, concealed pipes, chimneys and outside walls.

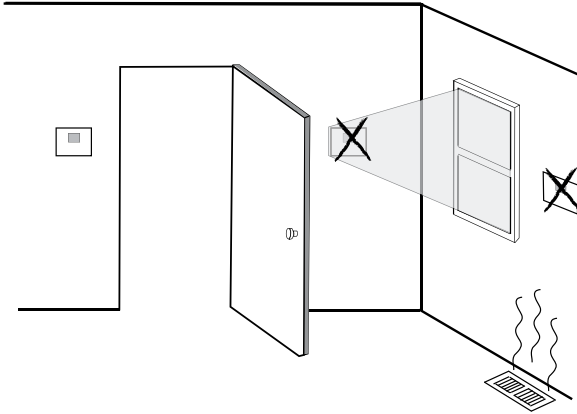

Install your new Braeburn thermostat in 4 basic steps:

- 1 Install the Sub-Base
- 2 Provide Power
- 3 Connect Your Wires
- 4 Attach Thermostat to Sub-Base

1 Install the Sub-Base:

- Remove the sub-base from the body of the thermostat.
- Mount the sub-base as shown below:

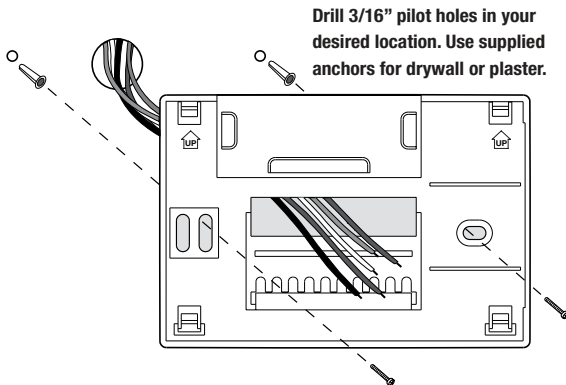

2 Provide Power

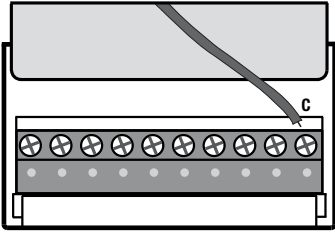

24VAC Power Terminal (C)

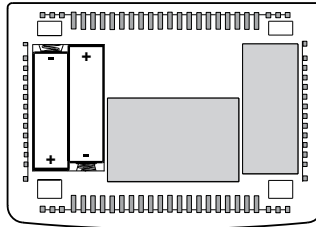

Batteries Installed as Shown

- For 24 Volt AC power, you must connect the common side of the transformer to the C terminal on the thermostat sub-base. In dual transformer installations, the transformer common must come from the cooling transformer.
- For battery power, insert the 2 supplied “AA” type alkaline batteries into the battery compartment located in the rear housing of the thermostat. Make sure to position the Positive (+) and Negative (-) sides of the batteries correctly with the +/- symbols in the battery compartment.
- **If connecting this thermostat to a Wi-Fi network, a 24 VAC common (C wire) is required for the following system types:**
 - Heat Only
 - Cool Only
 - Single Stage Heat Pump
 - Multistage Heat Pump

NOTE: If a common “C” wire is not being used, the 2 “AA” batteries must be installed.

3 Connecting Your Wires

Wiring Terminations

Terminal	Function	Description
Rc	Input	24 Volt AC Cooling Transformer (Dual Transformer Systems Only)
Rh	Input	Power Connection (24 Volt AC Heating Transformer)
G	Output	Fan Control
W1 / E / W3	Output	(W1) 1st Stage Conventional Heat, (E) Emergency Heat, (W3) 3rd Stage Auxiliary Heat
W2	Output	2nd Stage Conventional Heat
O / B	Output	(O) Cool Active Reversing Valve (B) Heat Active Reversing Valve
Y1	Output	1st Stage Compressor
Y2	Output	2nd Stage Compressor
C	Input	24 Volt AC Transformer Common
K	-	Optional Share-a-Wire® module connection (Model 7340)

Conventional Systems

Typical Wiring Configurations

NOTE: The “System Type” option will be configured in the Installer Settings section.

Heat Only*

Set System Type to **CONV 11**

Rh	Power Connection
W1	Heat Relay
G	Fan Relay [note 4]
C	24 Volt AC Transformer Common [note 1]

1 HEAT / 1 COOL Single or Dual Transformer

Set System Type to **CONV 11**

Rh	24 Volt AC Power (heating transformer) [note 2]
Rc	24 Volt AC Power (cooling transformer) [note 2]
W1	Heat Relay
Y1	Compressor Relay
G	Fan Relay
C	24 Volt AC Transformer Common [note 1, 3]

* 24 VAC Common (C wire) is required if using Wi-Fi on a Heat Only System Type.

2 HEAT / 2 COOL Single or Dual transformer

Set System Type to **CONV 22**

Rh	24 Volt AC Power (heating transformer) [note 2]
Rc	24 Volt AC Power (cooling transformer) [note 2]
W1	Heat Relay Stage 1
W2	Heat Relay Stage 2
Y1	Compressor Relay Stage 1
Y2	Compressor Relay Stage 2 [note 4]
G	Fan Relay
C	24 Volt AC Transformer Common [note 1, 3]

NOTES - Conventional Systems

- [1]** Optional 24 Volt AC common connection
- [2]** Only remove factory installed jumper for dual transformer systems.
- [3]** In dual transformer systems, transformer common must come from cooling transformer.
- [4]** If needed for system.

Provide disconnect and overload protection as required.

Heat Pump Systems

Typical Wiring Configurations

NOTE: The “System Type” option will be configured in the Installer Settings section.

1 HEAT / 1 COOL - No Auxiliary Heat

Set System Type to **HP 11**

Rh	24 Volt AC Power
Rc	Connected to Rh with supplied Jumper Wire
O/B	Changeover Valve [note 2]
Y1	Compressor Relay
G	Fan Relay
C	24 Volt AC Transformer Common [note 1]

2 HEAT / 2 COOL - No Auxiliary Heat

Set System Type to **HP 32**

Rh	24 Volt AC Power
Rc	Connected to Rh with supplied Jumper Wire
O/B	Changeover Valve [note 2]
Y1	Compressor 1 Relay (1st stage heating/cooling)
Y2	Compressor 2 Relay (2nd stage heating/cooling)
G	Fan Relay
C	24 Volt AC Transformer Common [note 1]

2 HEAT / 1 COOL - Including Auxiliary Heat

Set System Type to **HP 22**

Rh	24 Volt AC Power
Rc	Connected to Rh with supplied Jumper Wire
O/B	Changeover Valve [note 2]
Y1	Compressor Relay (1st stage heating/cooling)
W2	Auxiliary Heat Relay (2nd stage heating) [note 3]
E	Emergency Heat Relay [note 3]
G	Fan Relay
C	24 Volt AC Transformer Common [note 1]

3 HEAT / 2 COOL – Including Auxiliary Heat

Set System Type to **HP 32**

Rh	24 Volt AC Power
Rc	Connected to Rh with supplied Jumper Wire
O/B	Changeover Valve [note 2]
Y1	Compressor 1 Relay (1st stage heating/cooling)
Y2	Compressor 2 Relay (2nd stage heating/cooling)
W3	Auxiliary Heat Relay (3rd stage heating) [note 4]
G	Fan Relay
C	24 Volt AC Transformer Common [note 1]

NOTES - Heat Pump Systems

- [1]** Optional 24 Volt AC common connection **(required for Wi-Fi)**.
- [2]** O (cool active) or B (heat active) is selected in the Installer Settings menu.
- [3]** Install a field supplied jumper between the W2 and W1/E/W3 terminals if there is no separate emergency heat relay installed.
- [4]** If a separate emergency heat relay is installed, the W1/E/W3 terminal should have both the auxiliary heat relay and emergency heat relay connected.

Provide disconnect and overload protection as required.

Additional Wiring Options - All System Types

K	Share-a-Wire® Module
----------	----------------------

NOTE - Additional Wiring Options

Can be used to share a wire on existing installations where a common connection (C wire) is required.

See 7340 Share-a-Wire module for additional wiring requirements.

4 Attach Thermostat to Sub-Base

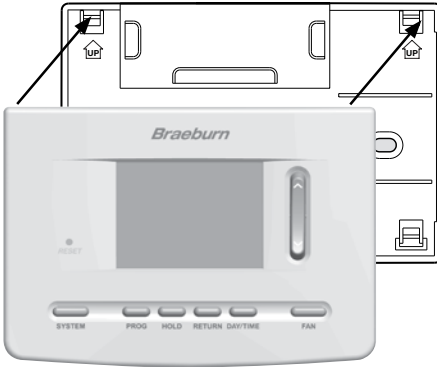

- 1) Line up the thermostat body with the sub-base.
- 2) Carefully push the thermostat body against the sub-base until it snaps in place.



- 3) Insert Quick Reference Card into slot on top of thermostat.

NOTE: This thermostat ships configured as a 1H/1C conventional thermostat. Confirm installer settings. See page 10.

3 Quick Reference

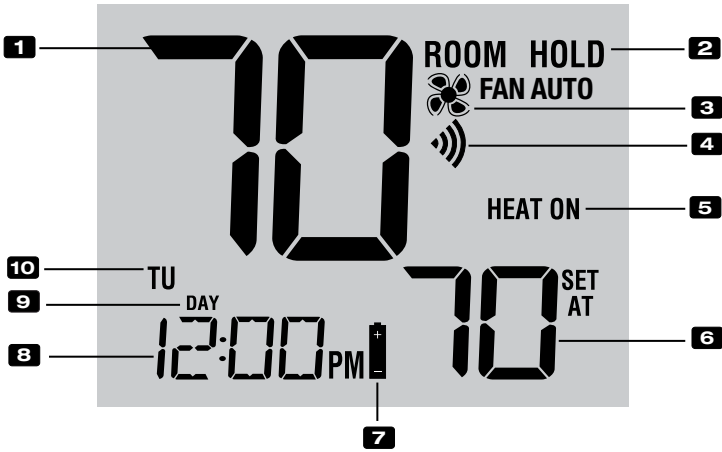

Thermostat Display

- 1** Room Temperature Displays the current room temperature
- 2** Hold Mode Indicator Indicates if the thermostat is in HOLD mode
- 3** Fan Indicator Indicates when the system fan is running
- 4** Wi-Fi Indicator Indicates when connected to Wi-Fi
(flashes when connection has been lost)
- 5** System Status Indicator Displays information about the status of the system
- 6** Set Temperature Displays the current set point temperature
- 7** Low Battery Indicator Indicates when the batteries need to be replaced
- 8** Time of Day Displays the current time of day
- 9** Program Event Indicator Displays the current program event
- 10** Day of the Week Displays the current day of the week

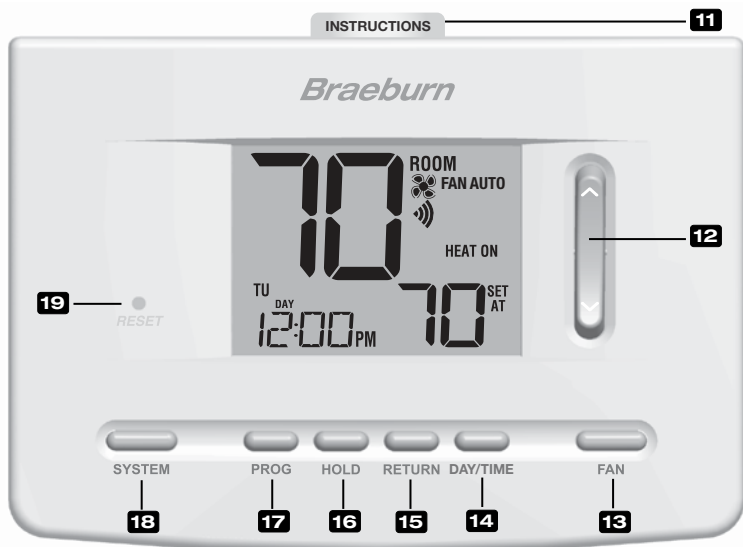

Thermostat

- 11 Quick Reference Instructions**..... Stored in slot located at top of thermostat
- 12 SpeedBar®** Increases or decreases settings (time, temperature, etc.)
- 13 FAN Button** Selects the system fan mode
- 14 DAY/TIME Button**..... Sets the current time and day of the week
- 15 RETURN Button** Returns to normal mode from program or a program override
- 16 HOLD Button**..... Enters/Exits the HOLD mode (program bypass)
- 17 PROG Button**..... Selects programming mode or press for 3 seconds to select SpeedSet®
- 18 SYSTEM Button** Selects the system you want to control
- 19 Reset Button** Resets current time, program and user settings
- Battery Compartment**..... Located in the back of thermostat

4 Installer Settings

The Installer Settings must be properly configured in order for this thermostat to operate correctly. The Installer Settings are menu driven. The portion of these settings that do not apply to your setup will be skipped. These settings are indicated below with comments. More detail on each setting follows this table.

To Change Installer Settings

1. Press and hold down the **RETURN** and **V** buttons for 3 seconds.
2. Release both buttons and the first installer setting will be displayed.*
3. Change settings as required using the **Λ** or **V** portion of the SpeedBar®.
4. Press **RETURN** to move to the next setting. After the last setting the thermostat will return to the main screen.

* If 0000 is displayed, you must enter your 4-digit installer lock code to proceed (see Installer Settings 19 and 20).

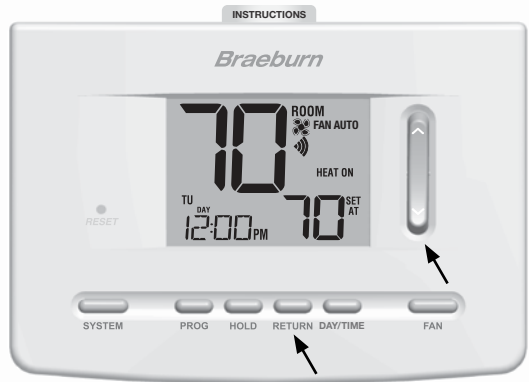

Press and hold down the **RETURN** and **V** buttons at the same time (3 seconds)
Press **RETURN** to move forward. Press **PROG** to move backward.

No.	Installer Setting (Notes follow this table)	Factory Default	Setting Options	Comments (More information follows this table)
1	Programming Mode	PROG 7	PROG 7 PROG 52 PROG NO	Select for 7 day programming mode Select for 5-2 day programming mode Select for non-programmable mode
2	Clock Format	HR 12	HR 12 HR 24	Select for 12 hour clock Select for 24 hour clock
3	Temperature Scale	DEG F	DEG F DEG C	Select for Fahrenheit display Select for Celsius display
4	System Type	CONV 11	CONV 11 CONV 22 HP 11 HP 22 HP 32	Select for 1H/1C Conventional system Select for 2H/2C Conventional system Select for 1H/1C Heat Pump system Select for 2H/2C Heat Pump system Select for 3H/2C Heat Pump system
5	1st Stage Differential	DIF1 0.5	DIF1 0.5, 1.0 or 2.0	Select a 1st stage temperature differential of .5°, 1° or 2° F (.25°, .5° or 2° C)
6	2nd Stage Differential [note 1]	DIF2 2.0	DIF2 1.0, 2.0, 3.0, 4.0, 5.0 or 6.0	Select a 2nd stage temperature differential of 1°, 2°, 3°, 4°, 5° or 6° F (.5°, 1°, 1.5°, 2°, 2.5° or 3° C)
7	3rd Stage Differential [note 1]	DIF3 2.0	DIF3 1.0, 2.0, 3.0, 4.0, 5.0 or 6.0	Select a 3rd stage temperature differential of 1°, 2°, 3°, 4°, 5° or 6° F (.5°, 1°, 1.5°, 2°, 2.5° or 3° C)
8	Auto Changeover	AUTO 0F	AUTO 0F AUTO 0n	Disables Auto Changeover mode Enables Auto Changeover mode

No.	Installer Setting (Notes follow this table)	Factory Default	Setting Options	Comments (More information follows this table)
9	Auto Changeover Dead Band [note 6]	BAND 3	BAND 2, 3, 4 or 5	Select a Dead Band of 2°, 3°, 4° or 5° F (1°, 2° or 3° C) for Auto Changeover mode.
10	1st Stage Fan Control [note 2]	FAN HG	FAN HG FAN HE	Select for 1st stage Gas heating Select for 1st stage Electric heating
11	Emergency Heat Fan Control [note 3]	EMER HE	EMER HE EMER HG	Select for Electric Emergency Heat Select for Gas Emergency Heat
12	Residual Cooling Fan Delay	FAN 60	FAN 90, 60, 30 or 0	Select a Residual Cooling Fan Delay of 90, 60, 30 or 0 seconds.
13	Circulating Fan Lock	CIRC oF	CIRC oF CIRC oN	Disables Circulating Fan Lock mode Enables Circulating Fan Lock mode
14	Reversing Valve (O/B Terminal) [note 4]	REV 0	REV 0 REV B	Select for cool active Reversing Valve (O terminal) Select for heat active Reversing Valve (B terminal)
15	Compressor Short Cycle Protection	CSCP 5	CSCP 5, 4, 3, 2 or 0	Select a compressor short cycle protection delay of 5, 4, 3, 2 or 0 minutes
16	Fossil Fuel Backup Heat [note 3]	AUX RE	AUX RE AUX AG	Select for Electric Auxiliary heat (with compressor) Select for Gas Auxiliary heat (without compressor)
17	Adaptive Recovery Mode (ARM™) [note 5]	REC oF	REC oF REC oN	Disables Adaptive (early) Recovery mode Enables Adaptive (early) Recovery mode
18	User Lockout Security Level	LOCK 2	LOCK 2 LOCK 1	If locked – Complete lockout is enabled If locked – Partial lockout is enabled (SpeedBar® is still functional). Note: Installer Settings can still be accessed with user lockout enabled.
19	Installer Lock	INST n0	INST n0 INST Y	Select for no Installer Lock Select to activate Installer Lock
20	Installer Lock Code [note 7]	0000 IL	0-9	Select a 4 digit code to lock the installer settings (cannot be 0000)
21	Heat Set Point Upper Limit	HIGH 90	HIGH 90-45	Select a Heat Set Point Upper Limit of 90°-45° F (32°-7° C)
22	Heat Set Point Lower Limit	LOW 45	LOW 45-90	Select a Heat Set Point Lower Limit of 45°-90° F (7°-32° C)
23	Cool Set Point Lower Limit	LOW 45	LOW 45-90	Select a Cool Set Point Lower Limit of 45°-90° F (7°-32° C)
24	Cool Set Point Upper Limit	HIGH 90	HIGH 90-45	Select a Cool Set Point Upper Limit of 90°-45° F (32°-7° C)
25	Installer Clear	CLR 0	CLR 0 CLR 2	Clear Off - No changes made to settings Clears all thermostat settings (factory defaults)

NOTE: Additional options such as Service Monitors, setting the lock code, etc. are located in the User Settings – See User manual for information on setting these options.

NOTES - Installer Settings

- 1 Only available if a 2 or 3 stage system type was selected in option 4.
- 2 Only available if a Conventional system was selected in option 4.
- 3 Only available if a 2 or 3 stage Heat Pump system was selected in option 4.
- 4 Only available if a Heat Pump system was selected in option 4.
- 5 Only available if a programmable profile was selected in option 1.
- 6 Only available if auto changeover was enabled in option 8.
- 7 Only available if Installer Lock was enabled in option 19.

Detailed Explanation of Installer Settings (also see NOTES above):

- 1 **Programming Mode** – Selects the programming mode, either full 7 day or 5-2 day (weekday/ weekend) programming or non-programmable.
- 2 **Clock Format** – Selects either a 12 hour or 24 hour clock.
- 3 **Temperature Scale** – Selects a temperature scale of either °F or °C.
- 4 **System Type** – Selects the system type for your installation. **NOTE:** *Changes made to this option will reset options 3, 5, 6, 7, 10, 11 and 12.*
- 5 **1st Stage Differential** – Selects a 1st stage temperature differential.
- 6 **2nd Stage Differential [note 1]** – Selects a 2nd stage temperature differential.
- 7 **3rd Stage Differential [note 1]** – Selects a 3rd stage temperature differential.
- 8 **Auto Changeover** – Selects auto changeover on or off. When auto changeover mode is enabled and selected, the system automatically switches between heating and cooling modes. There is a 5 minute delay when switching from heating to cooling or cooling to heating in auto changeover mode.
NOTE: *Also see "Auto Changeover Dead Band" in option 9.*
- 9 **Auto Changeover Dead Band [note 6]** – When auto changeover mode is enabled in option 5 and selected, the system automatically switches between heating and cooling when the room temperature meets the normal criteria for either a heating or cooling call. There is a forced separation (dead band) between the heating and cooling set points so that the systems do not work against each other. This option selects the amount of this dead band in degrees with the default being 3° F.
- 10 **1st Stage Fan Control [note 2]** – Selects a 1st stage fan control of either gas or electric heat.
- 11 **Emergency Heat Fan Control [note 3]** – Selects emergency heat fan control of either gas or electric heat.
- 12 **Residual Cooling Fan Delay** – Selects a delay for the system fan after the cooling compressor has turned off. This delay will help remove the remaining cool air out of the ductwork providing additional efficiency.
- 13 **Circulating Fan Lock** – When enabled, the only user fan options available are ON and CIRC (Circulation). The AUTO option is not available with this option enabled.
- 14 **Reversing Valve [note 4]** – Selects the output state of the O/B terminal. Select O for this terminal to be active in the cool mode or select B for this terminal to be active in the heat mode.
- 15 **Short Cycle Protection** – Selects the number of minutes the cooling compressor will be locked out after turning off. This short cycle protection is also active in the heat mode if a heat pump system was selected in Option 4.
- 16 **Auxiliary Fossil Fuel Heat Pump Control [note 3]** – When set to electric (AUX AE), both the compressor (1st stage) and auxiliary stage(s) will run when a call for auxiliary heat is made. When set to gas (AUX AG), the compressor stage(s) will be locked out one minute after a call for auxiliary heat.

- 17 Adaptive Recovery Mode (early recovery) [note 5]** – Enables or disables the ARM™ (adaptive recovery mode) feature. During ARM, room temperature is recovered by turning on the heating or cooling before the end of the set back period. The set point temperature is changed to that of the upcoming program temperature.
- 18 User Lockout Security Level** – Selects the level of keypad lockout when the thermostat is locked. Level 2 locks the entire thermostat (including the front reset button). Level 1 locks everything except the SpeedBar® allowing for up and down temperature adjustment. Installer Settings can still be accessed with user lockout enabled.
NOTE: The user lock code is set in the User Settings mode (see User Manual).
- 19 Installer Lock** – When YES (Y) is selected, a 4-digit lock code can be entered in option #20 to lock out the Installer Settings Mode. Select NO to skip installer lock.
- 20 Installer Lock Code [note 7]** – Select a 4-digit lock code (0-9) to lock the Installer Settings Mode.
NOTE: Lock code cannot be 0000.
- 21 Heat Set Point Upper Limit** – Selects the heating set point upper adjustment limit.
- 22 Heat Set Point Lower Limit** – Selects the heating set point lower adjustment limit.
- 23 Cool Set Point Lower Limit** – Selects the cooling set point lower adjustment limit.
- 24 Cool Set Point Upper Limit** – Selects the cooling set point upper adjustment limit.
- 25 Installer Clear** – Clears settings based on your selection. CLRO makes no changes and CLR2 clears **ALL** thermostat settings to factory default.
WARNING: If you press RETURN after selecting CLR2 the clear will take place and the appropriate settings will be returned to factory defaults. If you do not wish to make any changes, use the SpeedBar® to select CLRO.

5 System Testing



Warning *Read Before Testing*

- Do not short (or jumper) across terminals on the gas valve or at the heating or cooling system control board to test the thermostat installation. This could damage the thermostat and void the warranty.
- Do not select the COOL mode of operation if the outside temperature is below 50° F (10° C). This could possibly damage the controlled cooling system and may cause personal injury.
- This thermostat includes an automatic compressor protection feature to avoid potential damage to the compressor from short cycling. When testing the system, make sure to take this delay into account.

NOTE: *The compressor delay can be bypassed by pressing the reset button on the front of the thermostat. All user settings will be returned to factory default, however all Installer settings will remain as originally programmed in section 4.*

- 1 Press the **SYSTEM** button until the thermostat is in HEAT mode.
- 2 Using the SpeedBar® raise the set temperature a minimum of 3 degrees above the current room temperature. The system should start within a few seconds. With a gas heating system, the fan may not start right away.
- 3 Press **SYSTEM** until the thermostat is in the OFF mode. Allow the heating system to fully shut down.
- 4 Press **SYSTEM** until the thermostat is in the COOL mode.
- 5 Using the SpeedBar lower the set temperature a minimum of 3 degrees below the current room temperature. The system should start within a few seconds (unless compressor short cycle protection is active – See note above).
- 6 Press **SYSTEM** until the thermostat is in the OFF mode. Allow the cooling system to fully shut down.
- 7 Press **FAN** until the thermostat is in FAN ON mode. The system fan should start within a few seconds.
- 8 Press **FAN** until the thermostat is in FAN AUTO mode. Allow the system fan to turn off.

This equipment has been tested and found to comply with the limits for a Class B digital device, pursuant to Part 15 of the FCC Rules. These limits are designed to provide reasonable protection against harmful interference in a residential installation. This equipment generates uses and can radiate radio frequency energy and, if not installed and used in accordance with the instructions, may cause harmful interference to radio communications. However, there is no guarantee that interference will not occur in a particular installation. If this equipment does cause harmful interference to radio or television reception, which can be determined by turning the equipment off and on, the user is encouraged to try to correct the interference by one or more of the following measures:

- Reorient or relocate the receiving antenna.
- Increase the separation between the equipment and receiver.
- Connect the equipment into an outlet on a circuit different from that to which the receiver is connected.
- Consult the dealer or an experienced radio/TV technician for help.

Changes or modifications not expressly approved by the party responsible for compliance could void the user's authority to operate the equipment. This device complies with part 15 of the FCC Rules. Operation is subject to the following two conditions: (1) This device may not cause harmful interference, and (2) this device must accept any interference received, including interference that may cause undesired operation.

This device complies with Industry Canada's licence-exempt RSSs. Operation is subject to the following two conditions:

- (1) This device may not cause interference; and
- (2) This device must accept any interference received, including interference that may cause undesired operation of the device.

Cet appareil est conforme aux CNR exempts de licence d'Industrie Canada. Son fonctionnement est soumis aux deux conditions suivantes :

- (1) Ce dispositif ne peut causer des interférences ; et
- (2) Ce dispositif doit accepter toute interférence, y compris les interférences qui peuvent causer un mauvais fonctionnement de l'appareil.

Please Note: This thermostat may have been updated over the internet since this manual was printed. Always refer to the support web site for the latest information.

Limited Warranty

When installed by a professional contractor, this product is backed by a 5 year limited warranty. Limitations apply. For limitations, terms and conditions, you may obtain a full copy of this warranty:

- Visit us online: www.braeburnonline.com/warranty
- Phone us: 866.268.5599
- Write us: Braeburn Systems LLC
2215 Cornell Avenue
Montgomery, IL 60538



Store this manual for future reference.

For additional information visit: www.braeburnonline.com

For online access visit: www.bluelinksmartconnect.com

Braeburn[®]

Braeburn Systems LLC

2215 Cornell Avenue • Montgomery, IL 60538

Technical Assistance: www.braeburnonline.com

Call us toll-free: 866-268-5599 (U.S.)

630-844-1968 (Outside the U.S.)